

CNC-Machining Center
The complete package for your success!

OPTIMAT
BHC 550 - BHC 650

OPTIMAT BHC 550 with K-Table

Variable like your requirements

With the BHC550, we offer you the possibility to assemble your own individual CNC-Machining Center package from the many already proven configurations of our OPTIMAT series. With us as your CNC-partner, a machine concept is designed for you, which is best suited to your specific requirements. This flexible, modular concept has already proven successful in the field and is an integral feature of the BHC series of machines from WEEKE.

Proven components made by WEEKE Bohrsysteme have complemented and made the OPTIMAT series of the Homag Group successful. Different aggregates and configurations are now available, as you need them, on the new series of OPTIMAT machines. The different aggregates can be used on all machine models. Each machining head configuration (including double-sided) is compatible with each machine frame. Ride along tool changers in X- and Y-direction as well as different table variations insure a solid production machine with fast and efficient processing capabilities.

We continually develop our machines based on the daily experiences of our customers. As a result, we can offer you CNC solutions that remain flexible and open for the future

„If you want to be successful, you must accept the other's point of view and must consider the things with his eyes.“ (Henry Ford)

What are you waiting for? Come and be convinced.

WEEKE – your partner for the future.
Member of the HOMAG-Group.
Certified by DIN EN ISO 9001

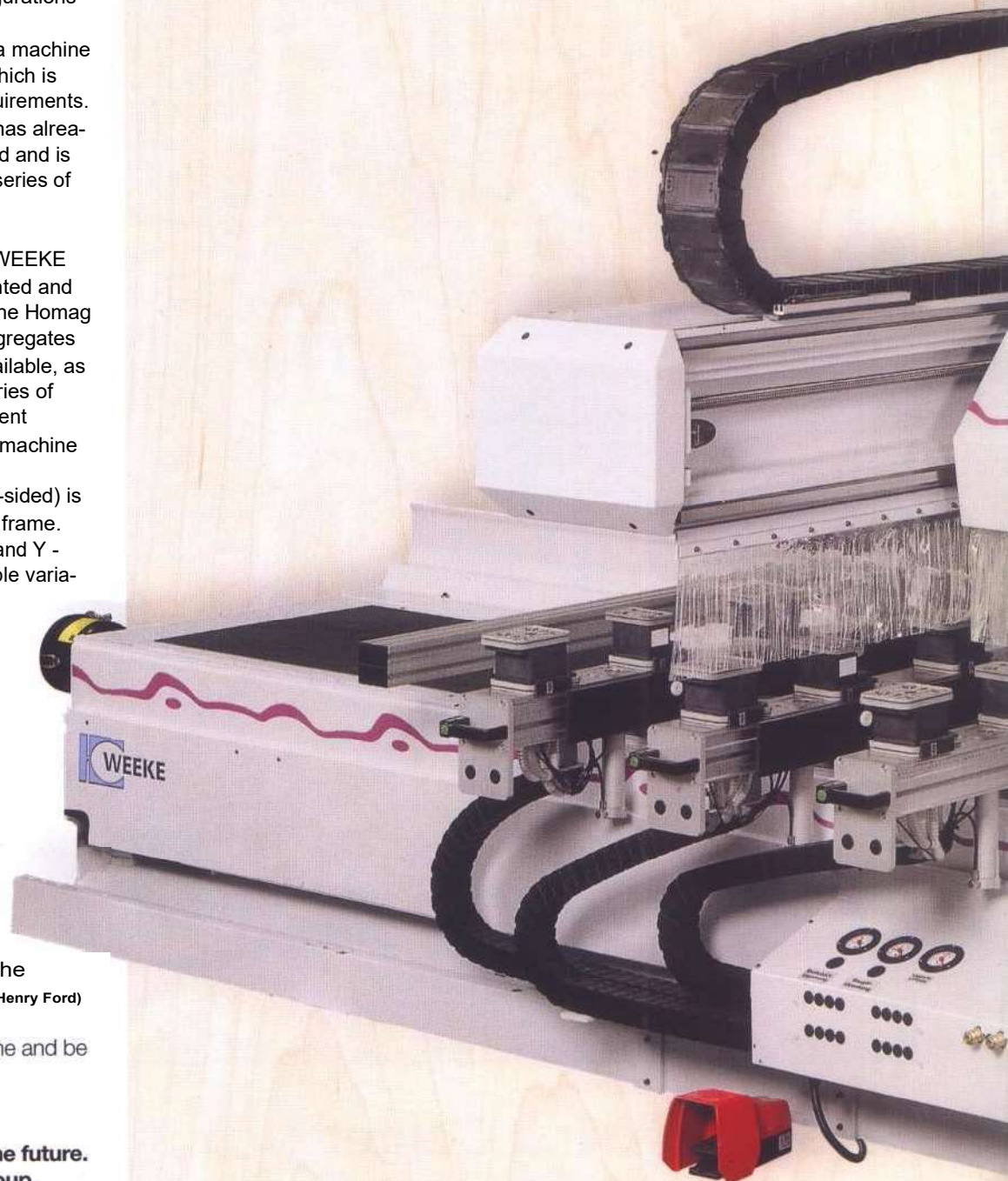

OPTIMAT BHC 550
with K-Table



Typical machining head configuration

OPTIMAT BHC 650 – Double-sided Capabilities

Your demands are our challenge.

You want ...

... the highest efficiency!?

Fast tool change times and the highest machining speeds guarantee this.

... the highest quality level!?

Our ISO 9001 certified production, backed by tight tolerance machining and assembly methods in our factory, guarantee the most reliable CNC machine for the long haul.

... a special machine configuration!?

Custom boring? Special routing? Some combination of both? With WEEKE, you have all the options that you need. Our modular system makes it all possible.

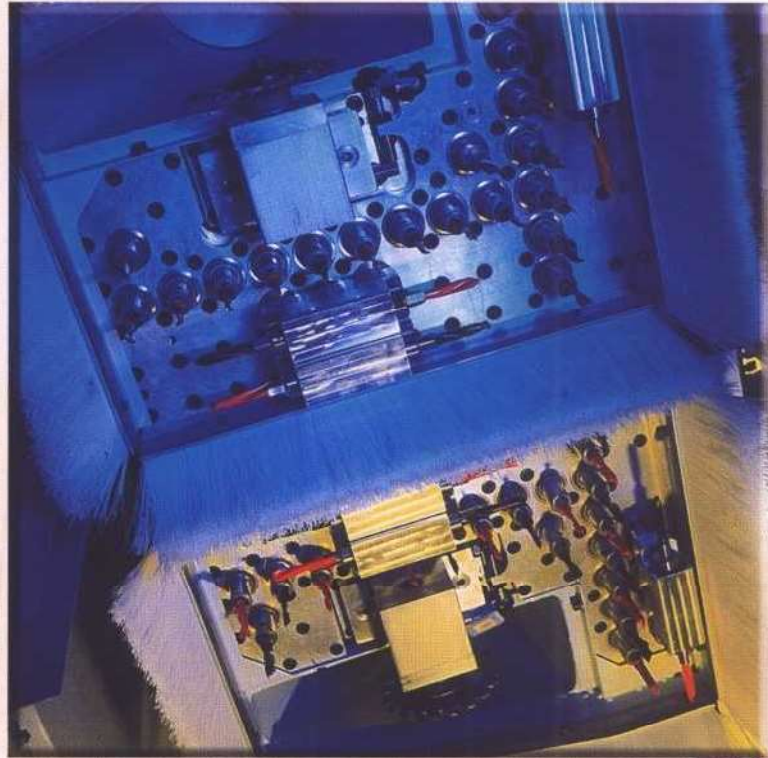

Typical machining head configuration

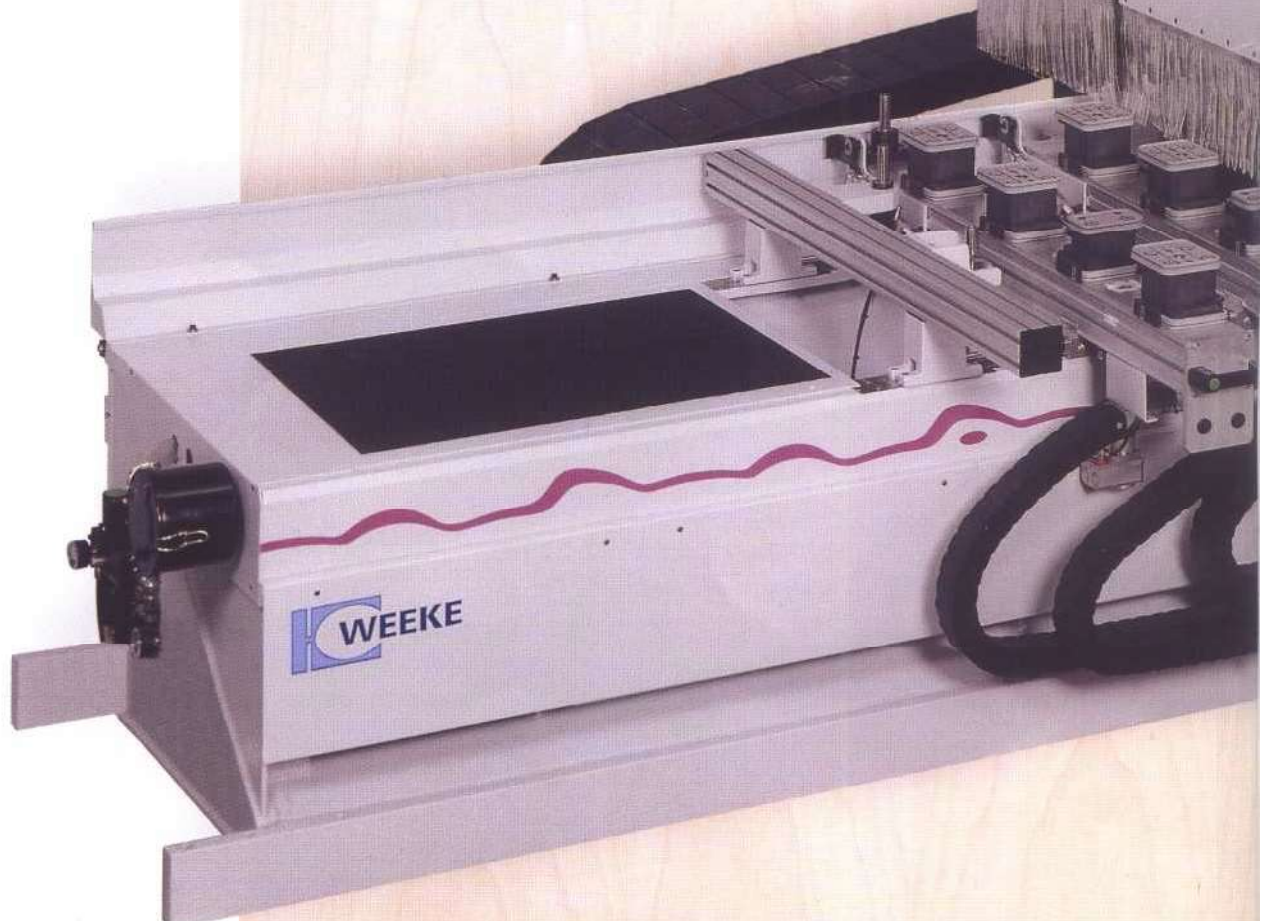

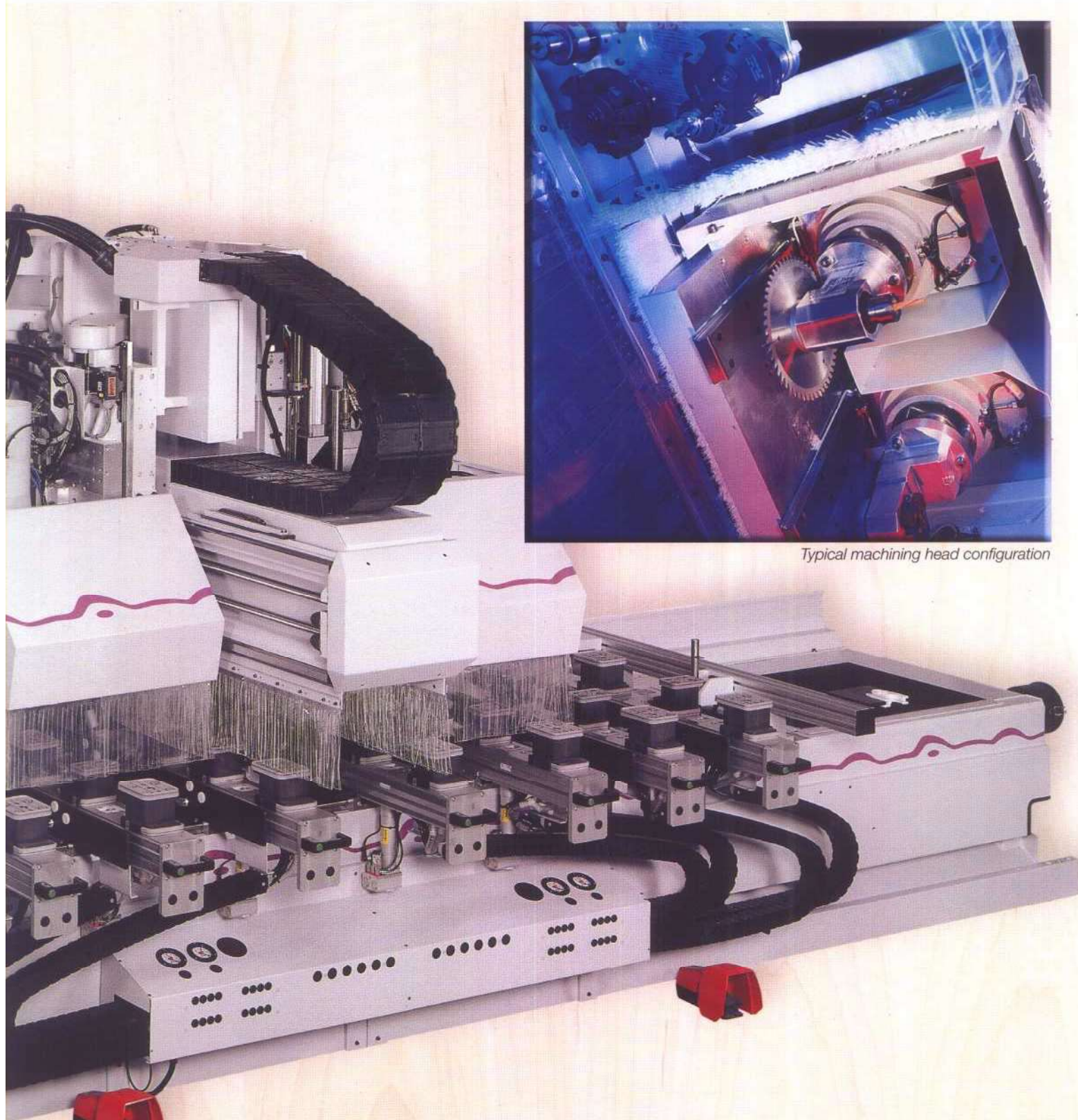

Typical machining head configuration

OPTIMAT BHC650
with K-Table

OPTIMAT BHC 550 with Matrix-Table and Basic-Table



Typical machining head configuration



OPTIMAT BHC 550
with Matrix-Table



Typical machining head configuration

OPTIMAT BHC550
with Basic-Table



The K-Table

Free Positioning of the Vacuum Pods

Tubeless and Highly Flexible

Clamping of workpieces is one of the most critical issues for the quality of CNC-machining. The combination of machine stability, quality tooling, and effective clamping guarantees a quality product coming off of the machine.

Based on these facts we developed the K-Table vacuum clamping system with free positioning vacuum pods. Our vacuum system gives you the utmost flexibility in clamping your workpiece. The K-Table solution also offers our mechanical multi clamping system. With this system it is simple to clamp unusual shaped parts or parts that would otherwise be difficult to hold down with a vacuum pod (i.e. window frames).

The following technical features illustrate the flexibility of the K-Table design:

- The side stops can be moved via hand lever - no limit in the workpiece length.
- A powerful vacuum pump, including an electronic vacuum control, insure solid clamping of the workpiece - manufacturing reliability even for porous materials and unusual shapes.
- A cross-hair laser, as well as scales and indicators on the benches and vacuum pods, are helpful for locating workpieces - operating reliability and fast part change-offers.
- Strong stops guarantee accurate positioning for all workpieces manufacturing reliability.
- Exchangeable gaskets for the vacuum pods - fast and easy to replace - low wear and spare parts costs.
- Up to 8 vacuum pods can be positioned on the workpiece console - high flexibility.
- Hold down devices and positioning stops in the front make ergonomic positioning of the workpieces possible - user-friendly.

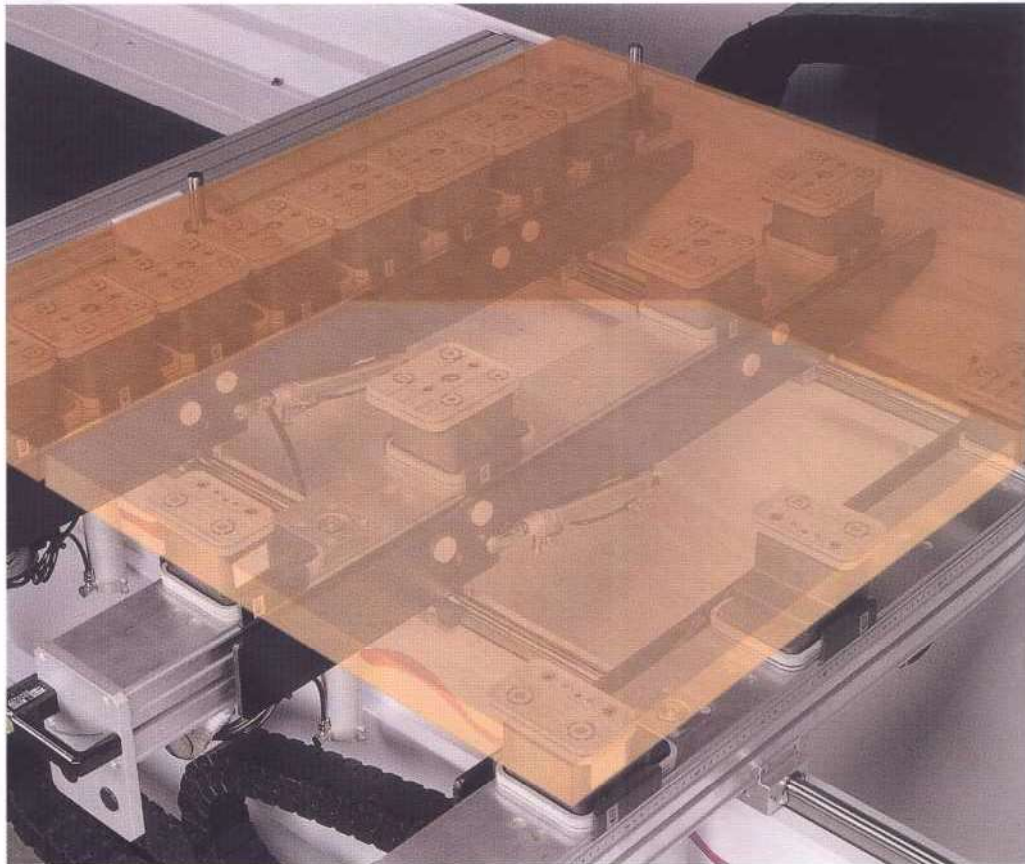

Up to 8 vacuum pods

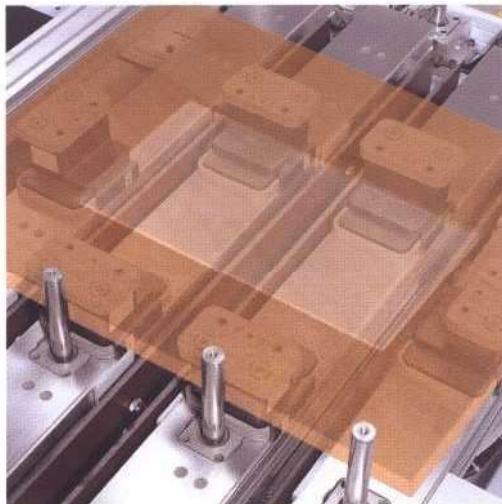

Vacuum pods length- and crosswise

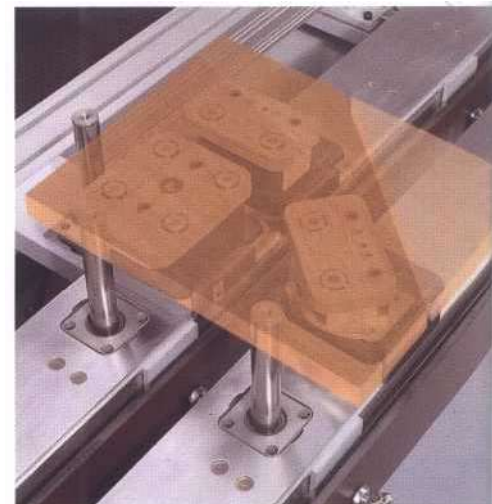

Narrow vacuum pods (0°-45° indexing)

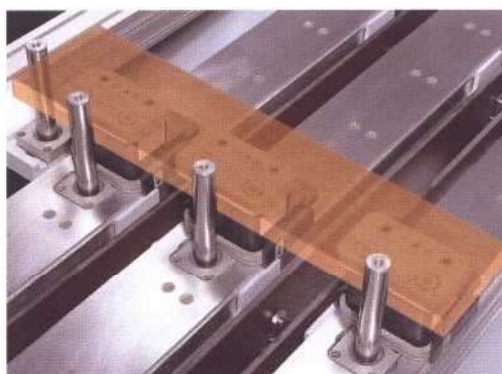

Narrow vacuum pods

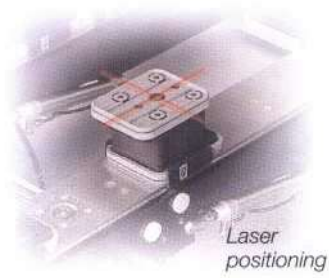

Laser positioning



A variety



Easy exchange of the rubber pod cover

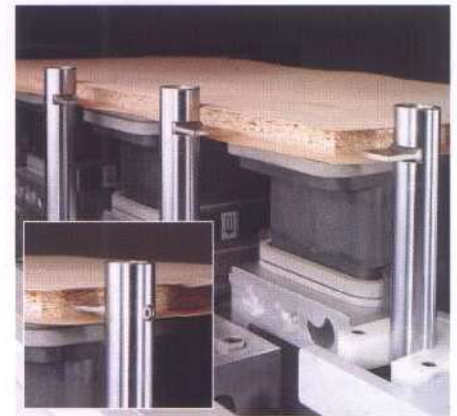

Rotating pneumatic stop for laminate or veneer overhang

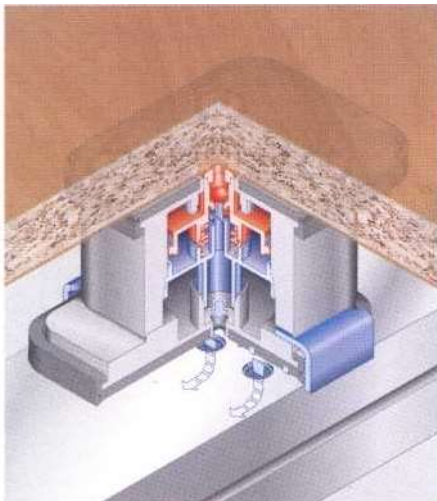

Functioning principle - parallel vacuum system within the pod

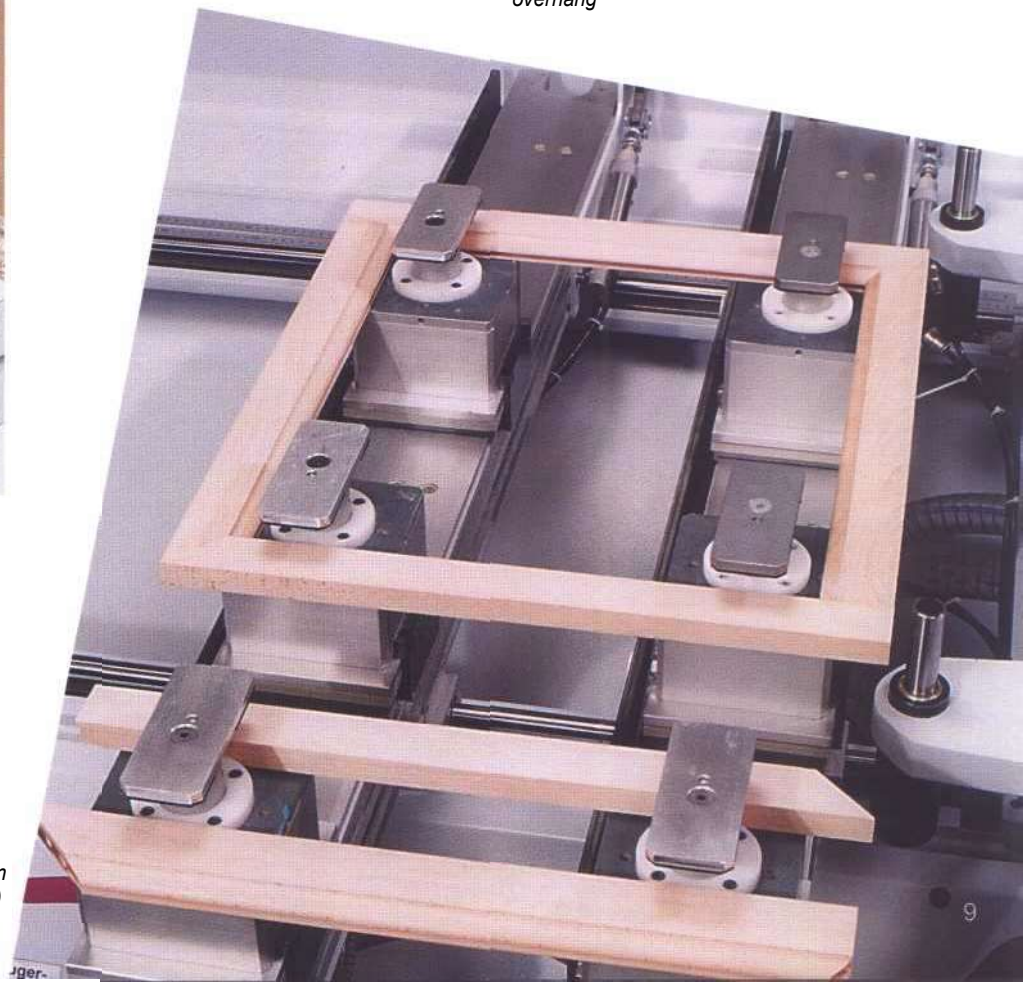

Multi clamping system (i. e. for frame parts)

The Matrix-Table Part Hold-Down Technology for Nested Based Manufacturing

NBM - Nested Based Manufacturing

What is NBM?

Processing of workpieces that are all contained within one sheet (or multiple sheets) of material.

Who needs NBM?

- The cabinet and casegood manufacturer
- Traditional furniture manufacturing
- Store fixture manufacturing
- Manufacturer of MDF Doors
- Component manufacturing

The manufacturing process:

Via NBM it is possible to process 15 panels per day. Depending on the explicit processing requirement a higher amount of panels per day can be achieved.

The panel is placed on the machining center and vacuumed down by a high volume, high-pressure vacuum system. The machining center then sizes, bores, saws and grooves the panel all from a single part program. The program is generated by software that is designed specifically for Nested Based Manufacturing applications. In 5-8 minutes the full sheet of material is complete and ready for the next step in your production process.

WEEKE Bohrsysteme offers you the complete NBM - package!



Part manufacturing with the NBM concept



Door manufacturing with the NBM concept

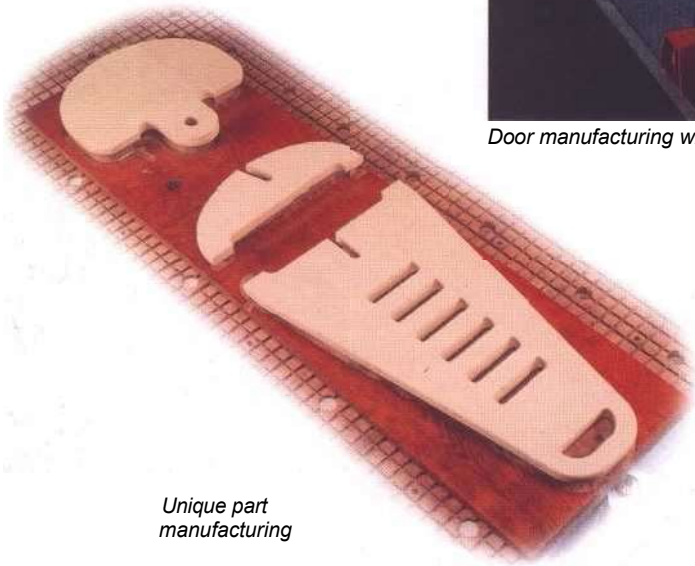

Unique part manufacturing



Single piece acrylic processing



Non-rectangular shaped parts in a nested sheet of material



Vaccum gasket system

Basic Principle of NBM
Matrix table/MDF vacuum bleeder board/workpiece
The vacuum for the workpiece comes directly through the MDF vacuum bleeder board



The Basic-Table – Reliable Part Hold-Down Technology

Our long established standard vacuum clamping system is once again optimized for your requirements.

Now with more flexible processing due to larger working fields and a second set of positioning stops

The standard vacuum pod table has been optimized as well and includes workpiece feeding rails



Front sops for



Laser positioning



Workpiece feeding rail



Back stops (c u



Mushroom clamps for narrow parts

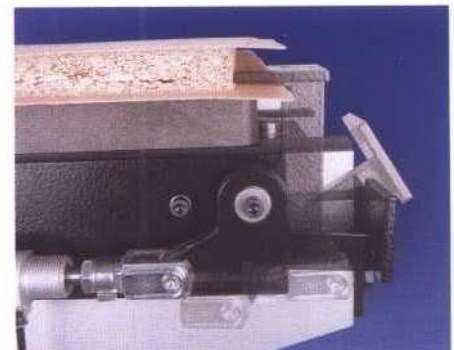

Backstops for parts with laminate and veneer overhang

The Main Spindle HSK 63 – High Performing and Reliable

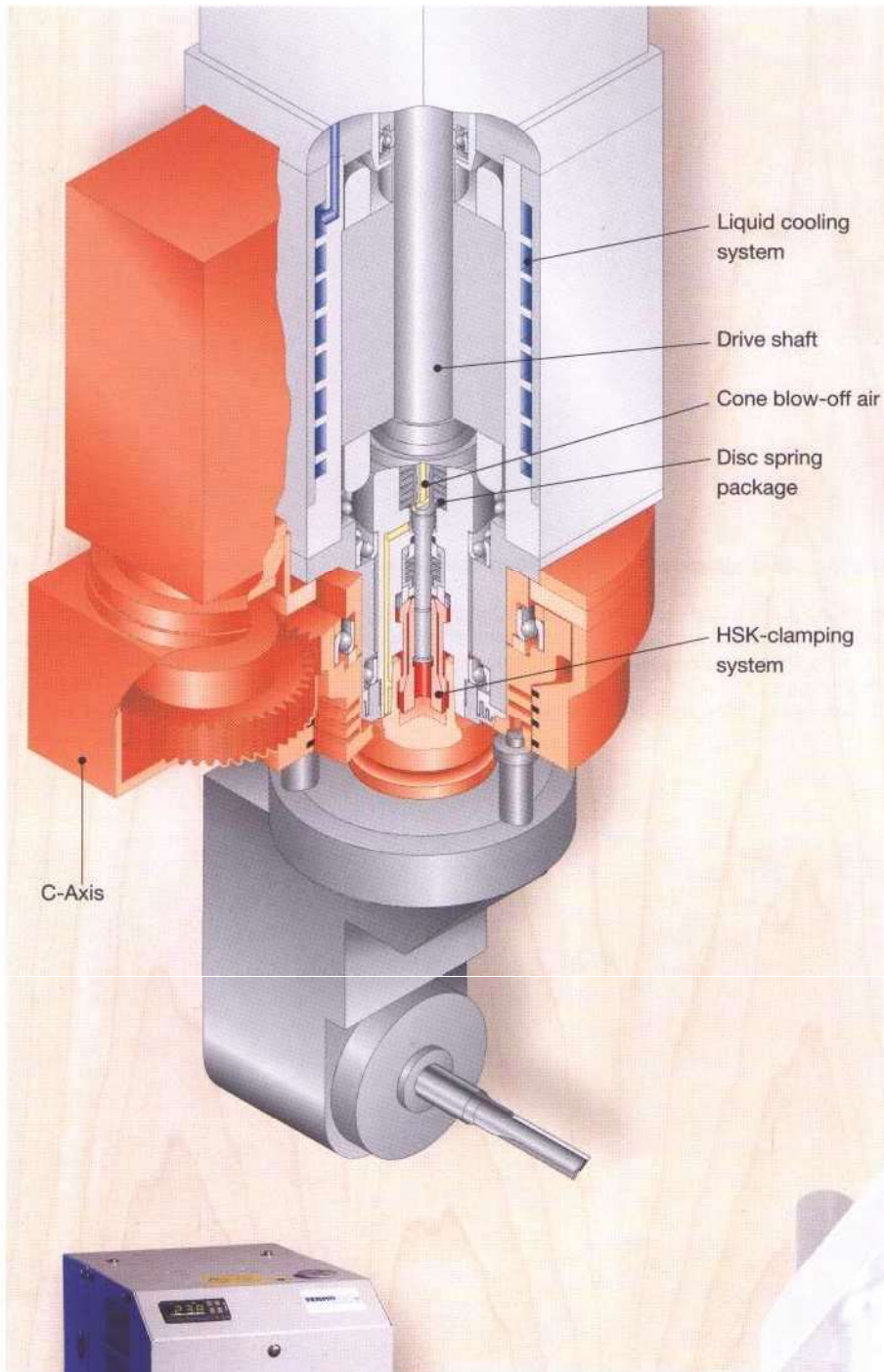

The OPTIMAT BHC550/650 are equipped with a strong HSK 63 main spindle and an automatic tool changer.

Innovative technology for truly demanding jobs.

The modern routing spindle has to manage today's challenges. The latest workpiece materials like MDF, solid surface material, Lexan and Plexiglas expect more from the heart of the machine - the main spindle. We accepted the challenge and designed our machine with:

Liquid cooling system

- Constant temperature even at high rpm and heavy routing.
- No heating at the bearings = high reliability
- Electronic sensors = long life

HSK tool interface

Although the SK-System (SK30 or SK 40) is very common the advantages of the HSK tooling interface are obvious. The increasing demand for quality and cutting quantity (volume) is causing higher cutting speeds. As a result there is an increase of rpm. With this increase there are higher centrifugal forces. The **HSK-System** clamps from the inside increasing centrifugal force causing more strength. The large surface between the tool holder and spindle and a force of 11 kN make this system unique. It is able to handle the challenge of today and tomorrow. The SK-Systems clamp from the outside. Increased centrifugal force weakens the system and reduces the cut quality.



Closed loop system for cooling

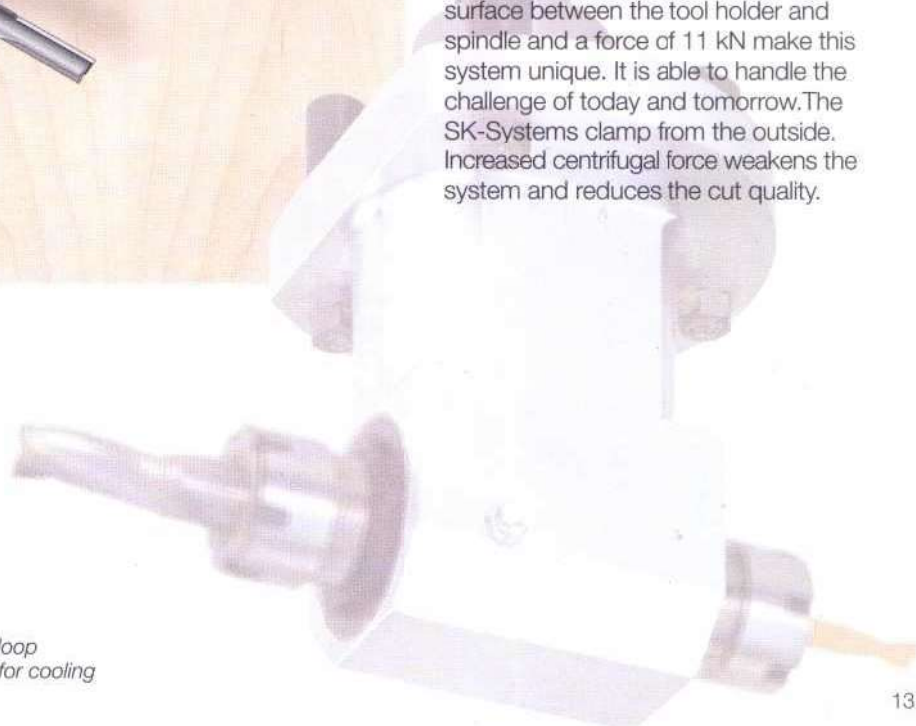

Our Aggregate Variety Ensure For Highest Flexibility In Your Manufacturing

Head configurations with fixed aggregates must be ordered up-front when buying the machine. You don't know what will happen in the future. WEEKE understood this problem and came up with a perfect solution: The aggregate capability gives you maximum flexibility. You don't have to look forward to the future when buying the machine. We will offer a solution which considers the demand of the future.

The C-axis

- safe and accurate fixing of the aggregates
- HSK 63-tooling interface
- three strong pins.

Advantage: -high operating quality
- high long tooling life

Free programming of the aggregates (360°) - processing with every angle.

The pneumatic interface

At place where air consumption is necessary the pneumatic interface is what you need - high accuracy for floating applications and a long tool life when routing a cam box.



Combination aggregate

*For boring, routing and sawing such as connections, grooves and through cuts etc. under any angle (0°-360)
Max saw blade diam. 180 mm.*



Routing aggregate

For boring and routing up to a depth of 40 mm under any angle (0°-360).



Cam box routing aggregate

For cam box routing, hinge slots and horizontal routing up to a depth of 125 mm (0°-360).



Routing vertical with tracer shoe

For routing in the workpiece surface, for routing of profiles or for tongue and groove connections, with C-axis controlled tracer shoe. Chips are being removed by the integrated blow nozzle (0°-360).



Routing vertical with tracing ring

For routing in the workpiece surface, for routing of profiles or for tongue and groove connections. The complete surface of the tracing ring can lie on the workpiece. Chips are being removed by the integrated blow nozzle (0°-360).



Routing vertical with tracing ring

For routing in the workpiece surface, for routing of profiles or for tongue and groove connections. The complete surface of the tracing ring can lie on the workpiece. Chips are being removed by the integrated blow nozzle.



Boring/sawing inclinable

For boring and sawing up to a depth of 50 mm under any angle (0°-360°).

The inclination of the borer or the saw blade can be adjusted manually (0°-90°).



Boring/routing inclinable

For boring and sawing up to a depth of 78 mm under any angle (0°-360°).

The inclination of the borer or the saw blade can be adjusted manually (0°-90°).



Boring/routing inclinable

For boring and sawing up to a depth of 78 mm under any angle (0°-360°).

The inclination of the borer or the saw blade can be adjusted manually (0°-90°).



Routing aggregate

2 spindles (clockwise/anticlockwise operation). For boring and routing up to a depth of 50 mm under any angle (0°-360°).



For sanding of MDF or solid wood edges. The sanding tool is continuously cleaned by a blow nozzle.



Boring aggregate

For hole row borings under any angle (0°-360°). Possible distances 25, 30, 32 or 50 mm).



Corner notching aggregate

For sharp-edged rectangular notching up to a material thickness of 25 mm under any angle (0°-360°).



The Robust Tool Change System

Ride along tool change system:

Advantage:

- NC-controlled equipping of the magazine
- easily accessible
- high safety comfort
- safety inquiry in tool changer
- fast and user-friendly
- X and Y ride along

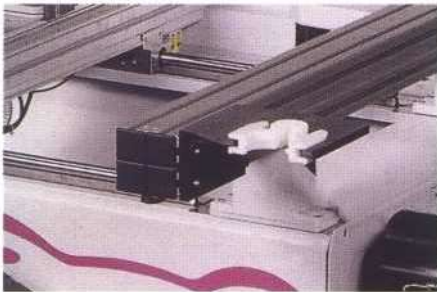

Tool holding place in front machine a,

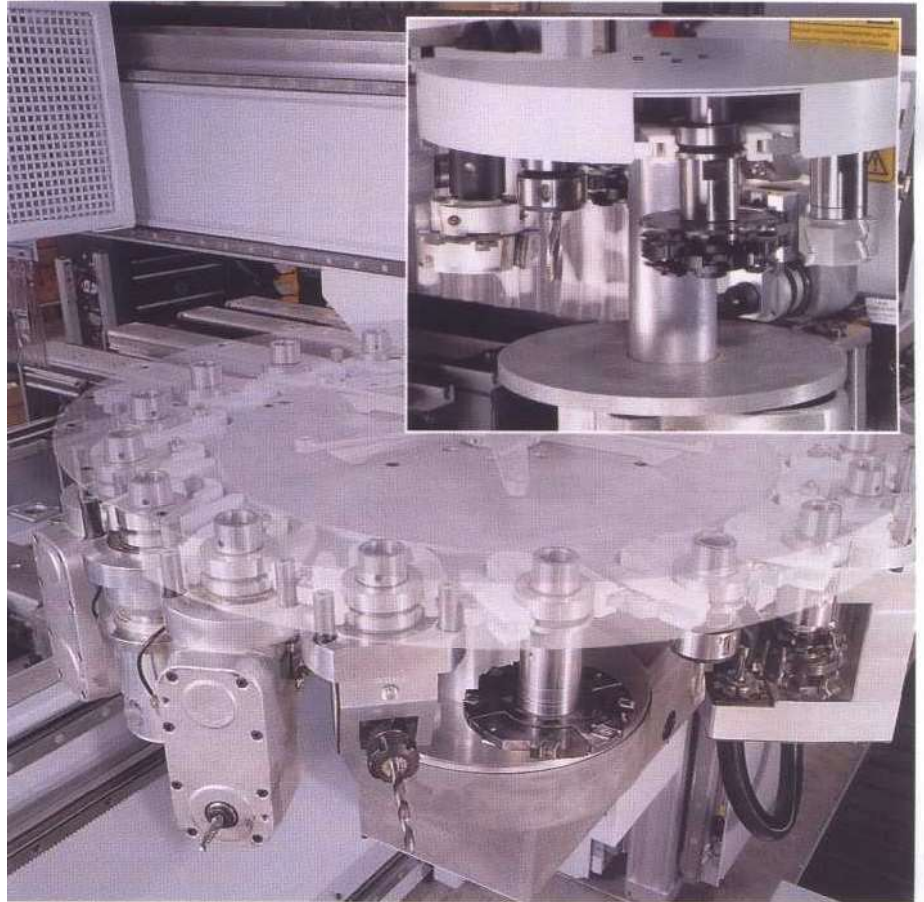

8- or 18-fold magazine in X-direction ride

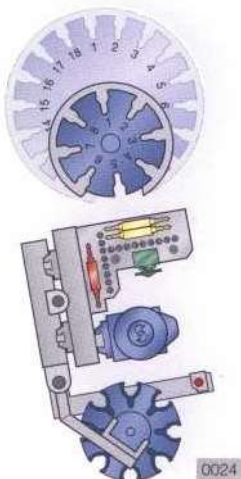
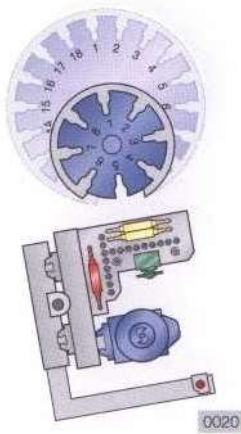

8-fold magazine in X- and Y-direction ride along

Highlights in Hard- and Software



The WoodWOP and the Homatic 2000 system is developed in close cooperation with you and our specialists.

Short cycle times are in our days a must. Any profit is realized by a fast and safe programming. Easy handling and high reliability you know already from your standard machines are

The interface between man and machine has been realized by WEEKE with a PC-System and the Microsoft Windows® world many years ago. Easy handling of the machine in the daily business is the result of this solution - you are moving in a confidential world. You know this world already from your home, it provides safety and confidence.

With WoodWOP you are going to program your success.

**WOP = Workshop - Orientated
- Programming**

With WoodWOP you do not program the machine and its movements but the panel and its processes.

The integration of the OPTIMAT BHC550/650 machine into your existing computer network and your barcode system are only few of many options. The control is already prepared for internet - or do you still receive drawings from architects by national post?

Numerous successful projects with well known manufacturers and suppliers of branch programs do not leave any wishes open in the CAD/CAM range.

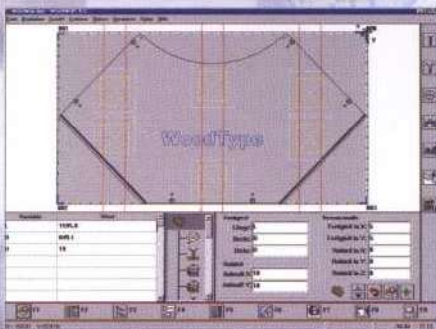
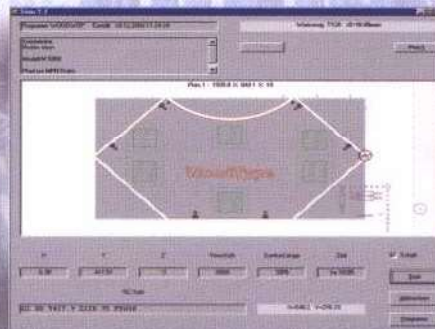
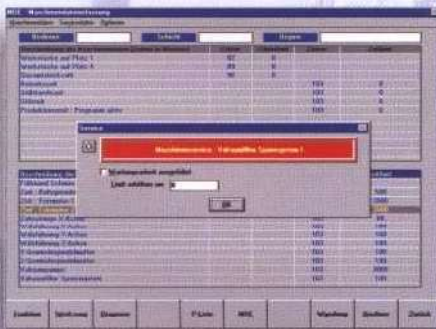

realized by the WoodWOP surface. Parametric programming and the possibility of component technique together with your know-how will lead to a maximum of productivity.

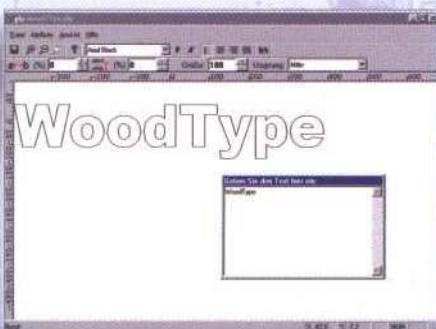

OPTIMAT BHC 550/650

The Technology In Overview

OPTIMAT BHC 550
with Basic-Table

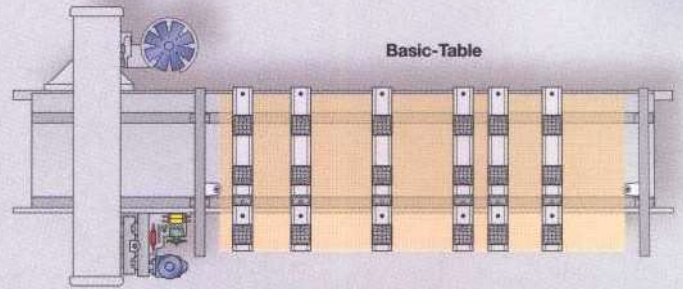

OPTIMAT BHC 550
with Matrix-Table

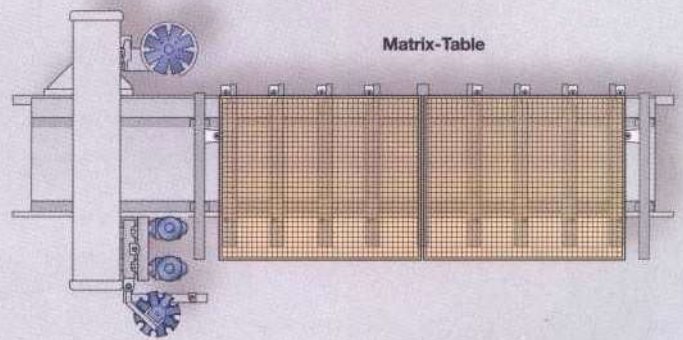

OPTIMAT BHC 550
with K-Table

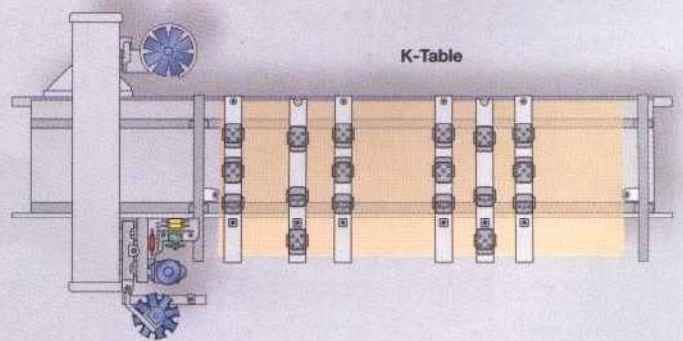

OPTIMAT BHC 650
with K-Table

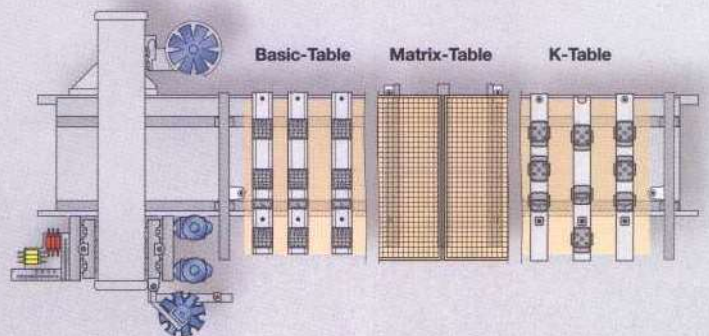
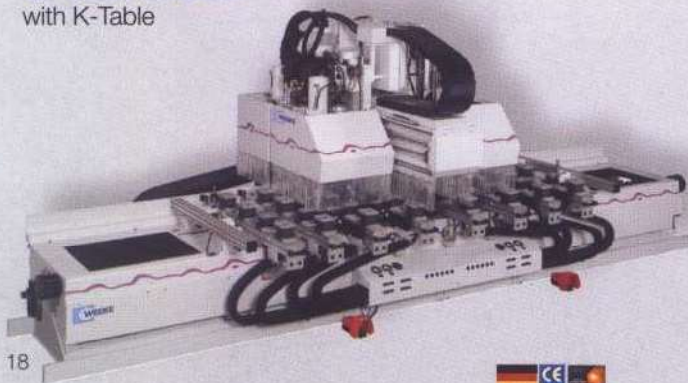

OPTIMAT BHC550

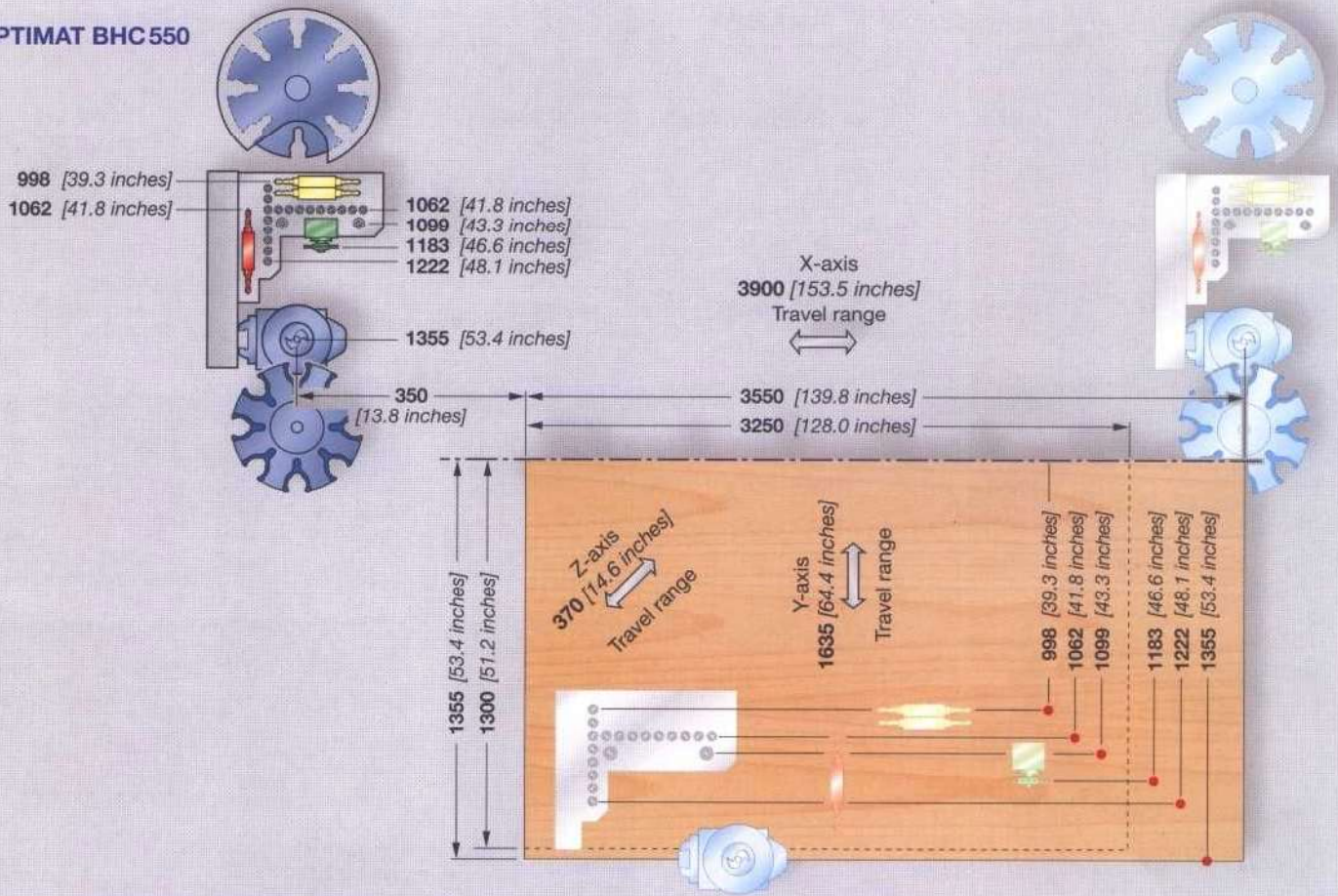

OPTIMAT BHC650

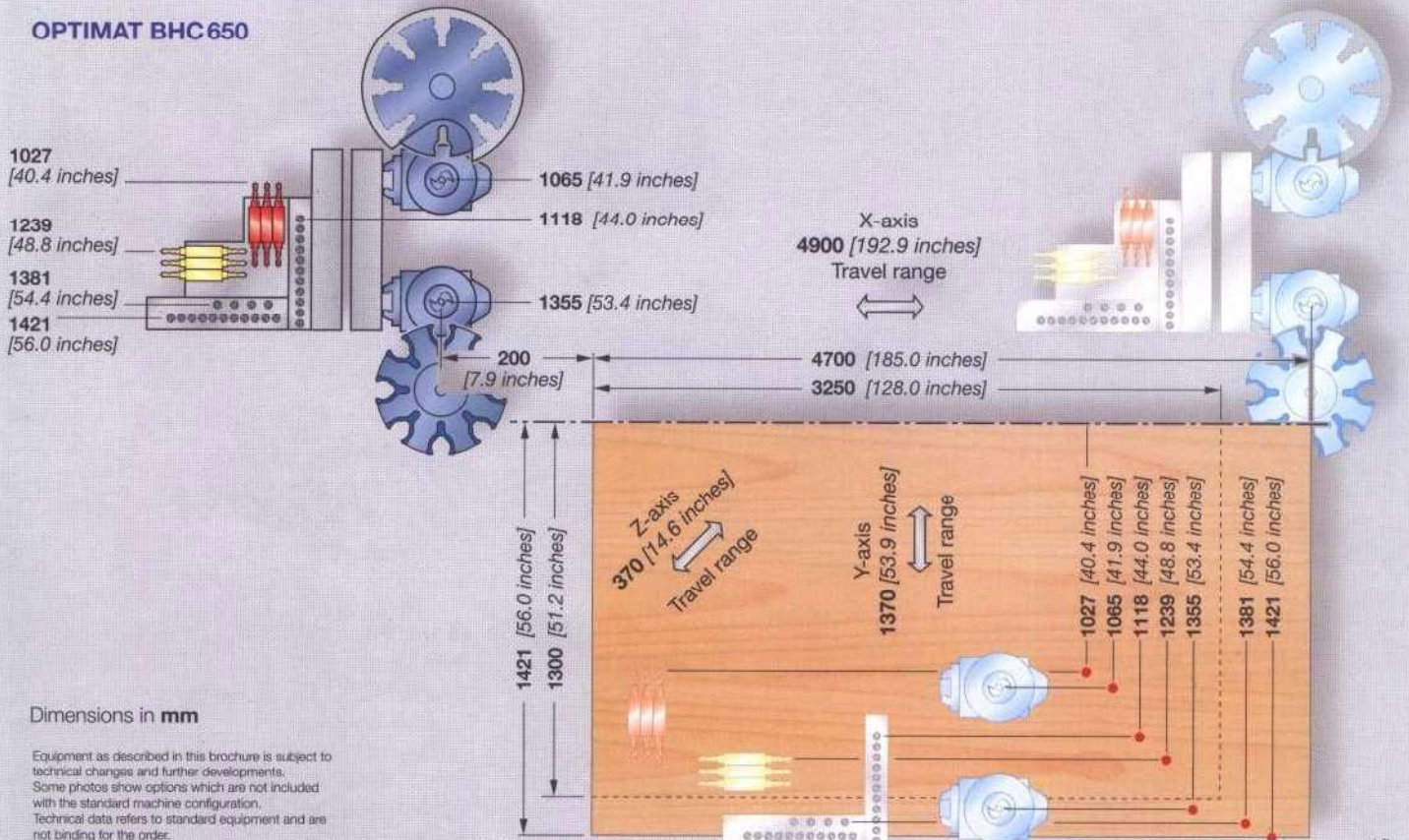

Dimensions in mm

Equipment as described in this brochure is subject to technical changes and further developments. Some photos show options which are not included with the standard machine configuration. Technical data refers to standard equipment and are not binding for the order.

TECHNICAL DATA

		BHC 550	BHC 650
Travel range of the Z-axis	mm	370	370
Maximum workpiece thickness	mm	100	100
Driving system of the axis		digital	digital
Positioning accuracy of the axis	mm	0.03	0.03
Rapid traverse rate X-Y-Z axes	m/min	80/60/20	80/60/20
Compressed air connection	Zoll	R 1/2	R 1/2
Compressed air required	bar	7	7
Vacuum pump capacity	m ³ /h	ab 100	ab 100
Dust extraction port diameter	mm	Ø 250	Ø 250 (1-2 x) + Ø 120 (1-2 x) Ø 160 (1-2 x)
Dust extraction air speed required	m/min	min. 28	min. 28
Dust Extraction Pressure drop	Pa	min. 2000	min. 2000
Dust extraction volume required	m ³ /h	min. 4950	varies according to the configuration
Electrical power – total connected load	kW	14-22	16-24
Total machine weight [with 3250 mm]	kg	approx. 4500	approx. 5600

OPTIMAT BHC550

Working length:	L	B
3250 [127.9 inches]	approx. 6380 [approx. 251.2 inches]	approx. 3900 [approx. 153.5 inches]
4250 [167.3 inches]	approx. 7380 [approx. 290.5 inches]	approx. 3900 [approx. 153.5 inches]
5250 [206.7 inches]	approx. 8380 [approx. 329.9 inches]	approx. 3900 [approx. 153.5 inches]

Option: Electrical control cabinet on **right** side

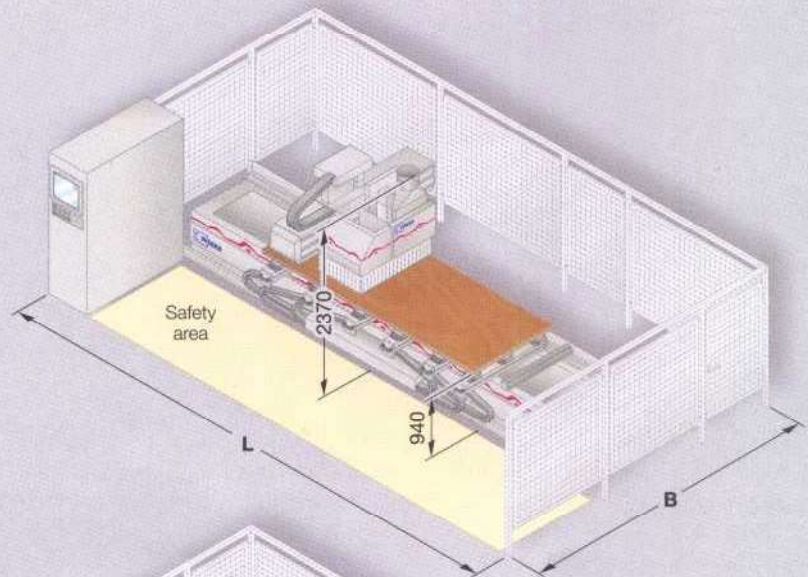

OPTIMAT BHC650

Working length:	L	B
3250 [127.9 inches]	approx. 8380 [approx. 251.2 inches]	approx. 4400 [approx. 173.2 inches]
4250 [167.3 inches]	approx. 9380 [approx. 369.3 inches]	approx. 4400 [approx. 173.2 inches]
5250 [206.7 inches]	approx. 10380 [approx. 408.7 inches]	approx. 4400 [approx. 173.2 inches]

Option: Switch cabinet on **left** side

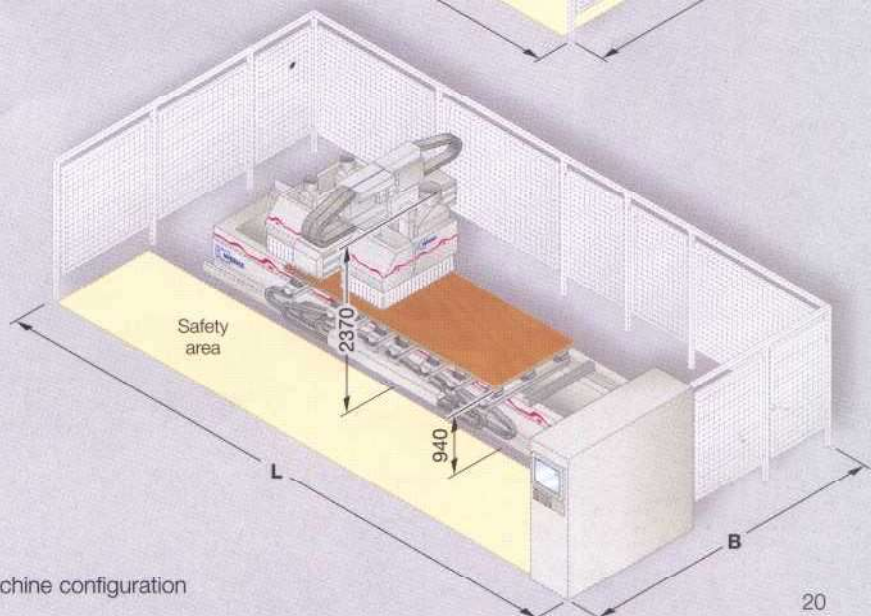

Dimensions in **mm**

Installation dimensions refer to the standard machine configuration

OPTIMAT BHC 550

Configuration Options

- ① 8-position tool change magazine ride along X-axis
- ② horizontal boring spindles (individually selectable) in X-axis
- ③ vertical boring spindles (individually selectable)
- ④ grooving saw aggregate
- ⑤ horizontal boring spindles (individually selectable) in Y-axis
- ⑥ liquid cooled router spindle
- ⑦ crosshair laser
- ⑧ 8-position tool change magazine ride along in both the X-and Y-axes

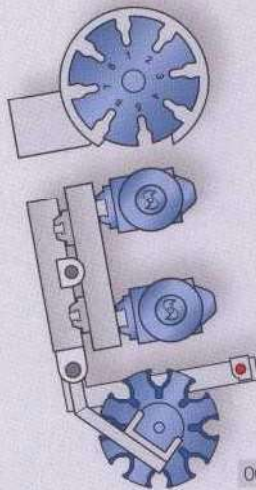

0030

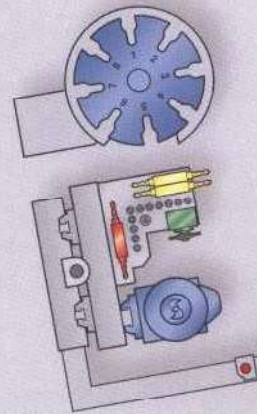

0019

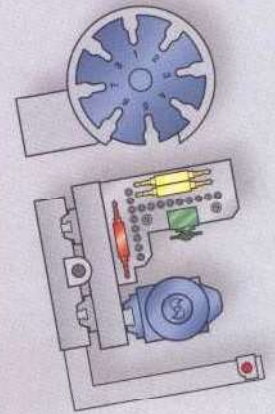

0020

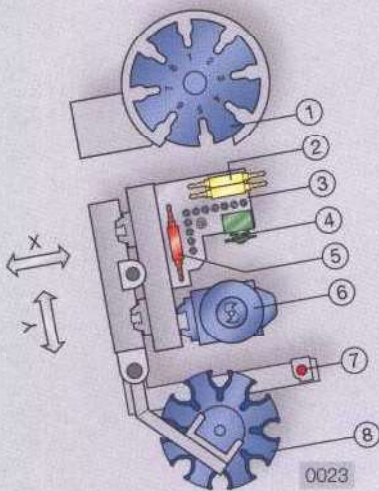

0023

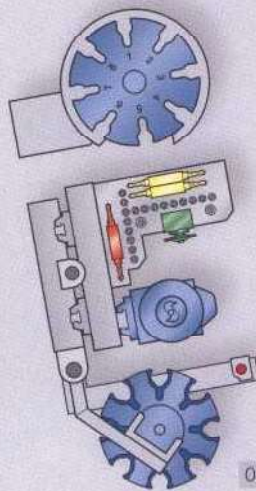

0024

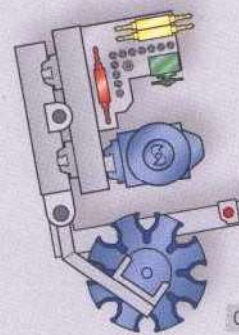

0021

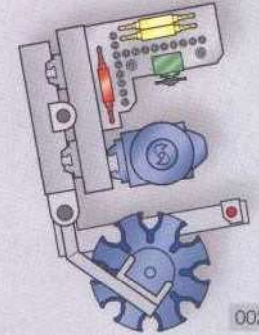

0022

OPTIMAT BHC 650

Configuration Options

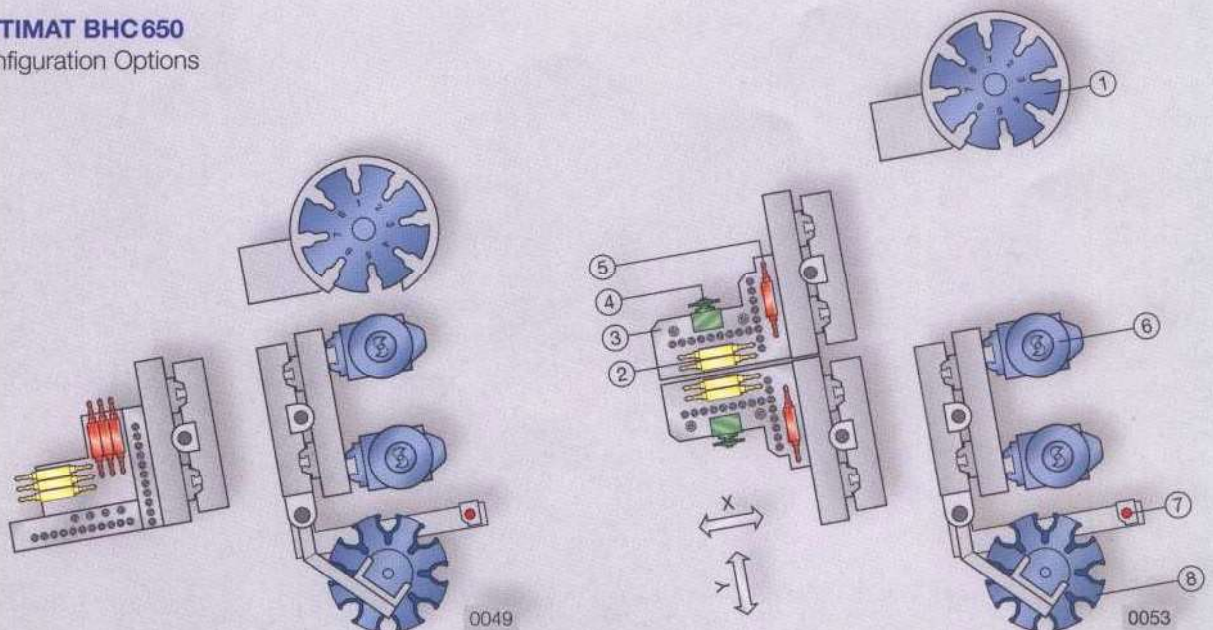

0049

0053

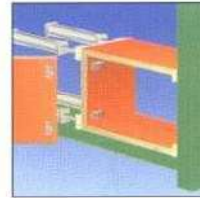
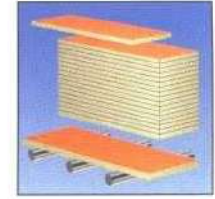
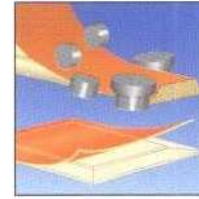
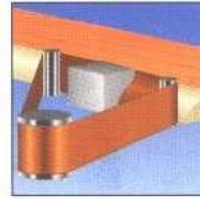
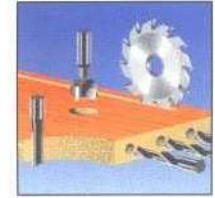
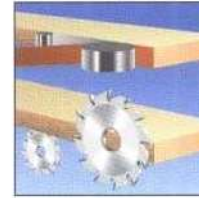
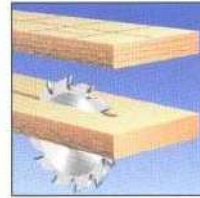

Your contact person:



WEEKE Bohrsysteme GmbH
 Benzstraße 10 - 16
 33442 HERZEBROCK-Clarholz
 GERMANY
 Phone +49-52 45-4 45-0
 Fax +49-52 45-4 45-139
 info@weeke.de
 www.weeke.de